

H-Burner Models

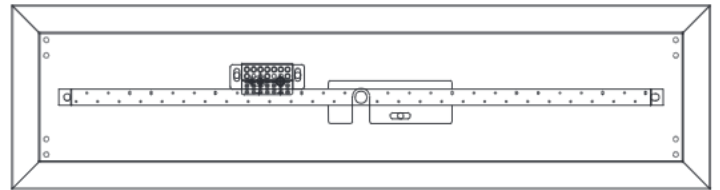

T-Burner Models

## MODELS

Natural Gas	Description
LOF-48LHTMSI-N	48" x 14" Linear Fire Pit with "H" Burner
LOF-48LTTMSI-N	48" x 6" Linear Fire Pit with "T" Burner
LOF-60LTTMSI-N	60" x 6" Linear Fire Pit with "T" Burner



## Pilot Operated Manual Spark Ignition (TMSI) Fire Pits Installation and Operating Instructions

**IF YOU CANNOT READ OR UNDERSTAND THESE INSTALLATION INSTRUCTIONS  
DO NOT ATTEMPT TO INSTALL OR OPERATE THIS APPLIANCE**

### INSTALLATION PRECAUTION:

This fire pit requires a minimum 18-square inches (per side) of cross ventilation.  
Failure to provide proper ventilation can void the warranty.





**Warning:** For Outdoor Use Only



We recommend that our gas hearth products be installed and serviced by professionals who are certified in the U.S. by the National Fireplace Institute® (NFI) as NFI Gas Specialists.

**PLEASE RETAIN THIS MANUAL FOR FUTURE REFERENCE**

 <p><b>DANGER</b></p>	<p align="center"><b>CARBON MONOXIDE HAZARD</b></p> <p>This appliance can produce carbon monoxide which has no odor.</p> <p>Using it in an enclosed area can kill you.</p> <p>Never use this appliance in an enclosed space such as a camper, tent, car or home.</p>
	

 **DANGER**

If you smell gas:

1. Shut off gas to the appliance
2. Extinguish any open flame.
3. If odor continues, keep away from the appliance and immediately call your gas supplier or fire department.

 **WARNING**

Do not store or use gasoline or other flammable vapors and liquids in the vicinity of this or other appliances.

Any LP cylinder not connected for use shall not be stored in the vicinity of this or other appliances.

**WARNING**

Do not leave unattended during use.  
Do not use for cooking.  
Follow all gas leak procedures in this manual prior to operation.

 **WARNING**

Improper installation, adjustment, alteration, service or maintenance can cause injury or property damage. Read the installation, operating and maintenance instructions thoroughly before installing or servicing this equipment.

**WARNING**

If the information in these instructions is not followed exactly, a fire or explosion may result causing property damage, personal injury or death.

**FOR YOUR SAFETY**

Do not store or use gasoline or other flammable vapors and liquids in the vicinity of this or other appliances.

 Fuels used in gas fired appliances, and the products of combustion such as fuels, contain chemicals known to cause cancer, birth defects and/or other reproductive harm. This warning is issued pursuant to the California Health & Safety Code Sec. 25249.1

## CALIFORNIA PROPOSITION 65



### WARNING

This product can expose you to Chromium, which is known to the state of California to cause cancer and birth defects or other reproductive harm.

(For more information, go to [www.p65warnings.ca.gov](http://www.p65warnings.ca.gov))

**NOTE:** An exterior lid/cover is not required but highly recommended when the fire pit is not in use. Even though fire pits are designed for outdoors they are not impervious to all weather conditions if not protected. See the accessory page for information and sizes.

### TABLE OF CONTENTS

<b>Specifications</b>	4-5
<b>Preparation for Non-Combustible Structure</b>	6
Hard Piping to Fire Pit	6
Cross Ventilation Requirements	6
High Elevation	6
Gas Pipe Sizing Chart	7
<b>Installation into an Approved Enclosure</b>	8
Requirements	8
Installing Control Panel	8
Typical Installation Drawings	9
<b>Operation</b>	10
Lighting Instructions	10
<b>Replacement Parts</b>	11
<b>Replacement Parts List</b>	12
<b>Media Requirements</b>	12
<b>Fire Pit Maintenance/Trouble Shooting</b>	13
<b>Optional Accessories</b>	13
<b>LP Conversion Instructions</b>	14



All media (i.e. lava rock, lava stones, lava boulders and fire glass) has the potential of thermal spalling. This is a process that may occur when media is wet and moisture gets trapped inside of the material due to rapid temperature differences. When this happens the media has the potential to crack or “pop” outside the fireplace.

#### WE HIGHLY RECOMMEND COVERING ALL FIRE FEATURES WHEN NOT IN USE

The use of a cover can lessen the impact of thermal spalling; however, heavy rains, high humidity and the presence of moisture may still cause the media to pop.

#### ALWAYS USE CAUTION WHEN USING THE FIRE FEATURE

Extra caution should be taken when lighting a fireplace when heavy rains, high humidity and moisture are present. Light the fireplace; leave the area allowing any moisture in the media to dissipate. We strongly recommend that during this drying out time that you monitor the fire feature from a distance. This drying out period should be no less than 30 minutes. Continue monitoring the flame from distance to ensure that all popping has ceased before fully enjoying the fire.

## SPECIFICATIONS

MODELS	INSIDE PAN DIMENSIONS A	BURNER LENGTH B	OVERALL PAN WIDTH C	OVERALL LENGTH D	BURNER TUBE TO PAN E	PAN DEPTH F	LIP THICKNESS G	PAN LIP WIDTH H
LOF-48LHTMSI-N	48" x 14" (1219 x 254mm)	44" (1117mm)	16½" (419mm)	50½" (1283mm)	2¼" (57mm)	2½" (64mm)	⅜" (10mm)	1¼" (32mm)
LOF-48LTTMSI-N	48"x 6" (1219 x 152mm)	45" (1143mm)	8 ½" (216mm)	50½" (1283mm)	2¼" (57mm)	2½" (64mm)	⅜" (10mm)	1¼" (32mm)
LOF-60LTTMSI-N	60"x 6" (1524 x 152mm)	57" (1448mm)	8 ½" (216mm)	62½" (1588mm)	2¼" (57mm)	2½" (64mm)	⅜" (10mm)	1¼" (32mm)

Table 1 Fire Pit Dimensions

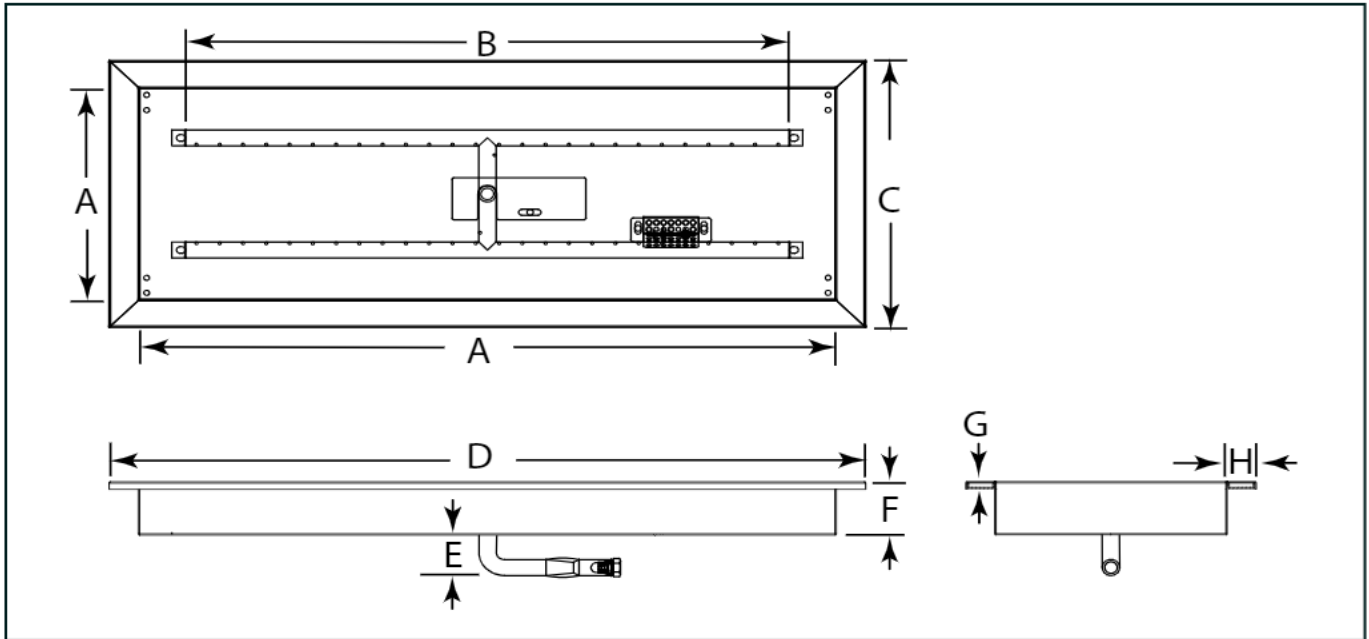

Fig. 1 H-style burner pan specifications.

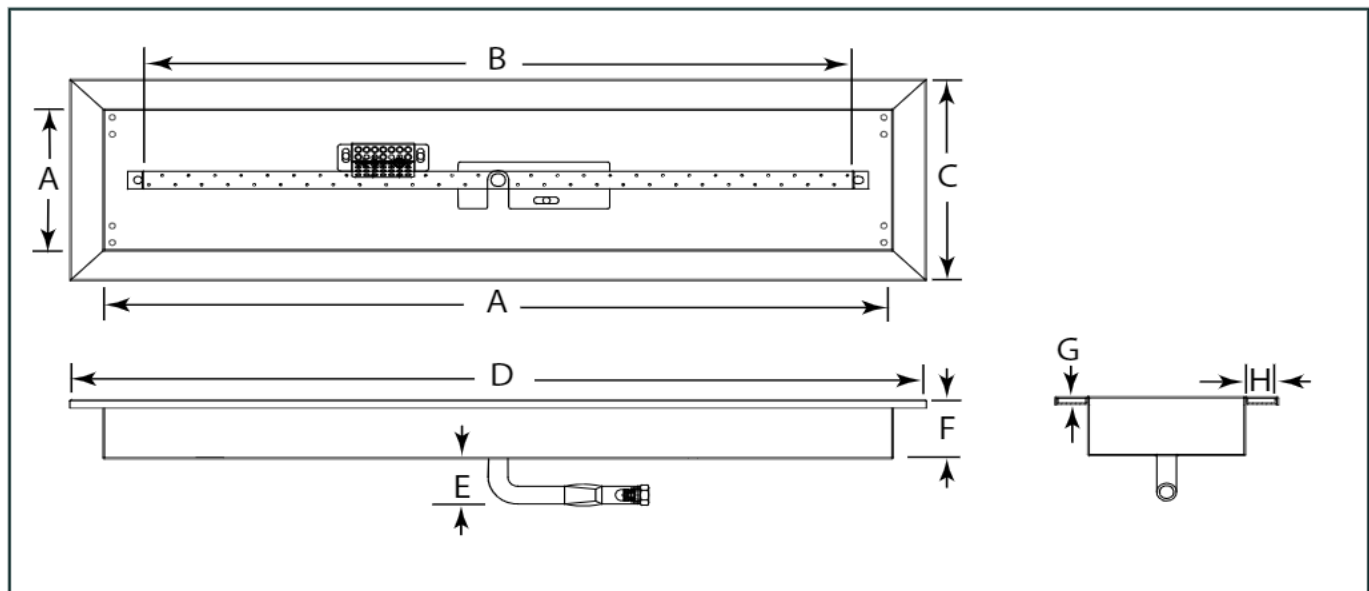
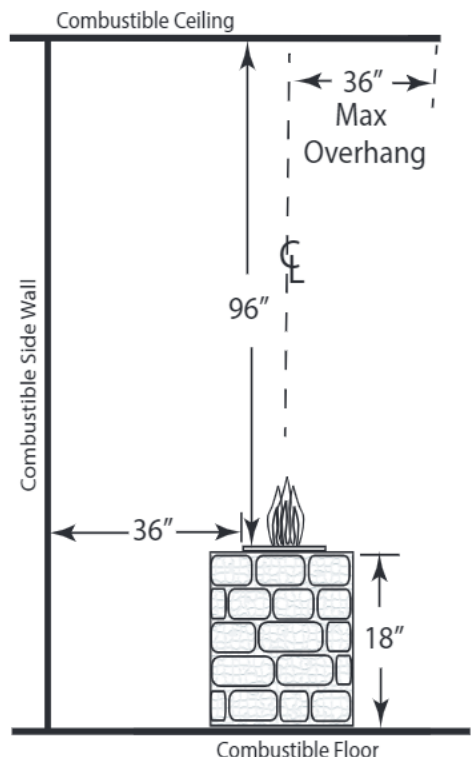

Fig. 2 T-style burner pan specifications.

Model: MT Natural Gas (NG)	NG Factory Orifice	BTU's Natural	LP Factory Orifice	BTU's Propane (LP)
LOF-48LHTMSI-N	#3 (5.56mm)	145,000	#21 (4.20mm)	95,000
LOF-48LTTMSI-N	#3 (5.56mm)	145,000	#21 (4.20mm)	95,000
LOF-60LTTMSI-N	#3 (5.56mm)	145,000	#21 (4.20mm)	95,000

**Table 2** Btu Specifications

**Disclaimer:** Btu listings are based on 7.0"WC for Natural Gas and 11.0"WC for Liquid Propane (LP) at the burner orifice. Flex line size and proper gas pipe sizing will also affect Btu's. As a result your Btu's may vary slightly from Table 2 specifications.



**Fig. 3** Clearance to Combustibles (Not to be used in an enclosed space)

Pressure	NG	LP
Min. Inlet	3.5" WC	8.0" WC
Max. Inlet	10.5" WC	13.0" WC
Normal Inlet	7.0" WC	11.0" WC

**Table 3** Gas Pressures

**WARNING:** Proper clearances from combustibile materials must be maintained from all sides, top and bottom of this appliance. Use the specifications listed on pages 4 and 5 for proper clearance to combustibles.

**Description:** These fire pits are designed to be installed into a non-combustibile enclosure. They are a "drop-in" style system to make installation quick and convenient. Due to the length of the thermocouple wire the control panel must be mounted within 24" of the burnerpan. These fire pits use a standing pilot gas valve with a manual Piezo ignition system. This system has a battery operated manual Piezo ignition to light the burner, then uses a thermocouple to keep the fire pit burning during operation. If the flame for any reason is blown out or extinguished the thermocouple will cool down and shut the gas supply OFF. Media (not supplied) is required inside the burner pan for operation (See page 12).

Firegear Outdoors fire pits are constructed and tested to follow the rigid ANSI standards for gas appliances and manufactured safely providing dependable and certified products. If these fire pits are not installed according to the installation manual (i.e. not providing ventilation, not providing proper drainage, installing fire pits below grade or modifying the existing products from a normal installation) Firegear Outdoors cannot be responsible if the product does not operate as designed.

Modifying the fire pit directly out of the carton will void the warranty and nullify the CSA listing it was certified for. Before you consider creating your own custom design with a certified product ensure you contact Firegear Outdoors to consult the installation before proceeding. If you move forward and modify a product without consulting, Firegear Outdoors cannot be responsible if the product does not operate as designed.





## PREPARING A NON-COMBUSTIBLE STRUCTURE

The fire pit can be installed on a flat, stable surface, away from any combustible materials. Install fire pit on any level, outdoor non-combustible, flat stable surface or a combustible floor according to the clearances specified in this manual. **NOTE:** Do not place fire pit directly on grass, dirt, or rocks this may prevent proper ventilation. **Ensure proper water drainage is also incorporated into the fire pit enclosure.**

### HARD PIPING TO FIRE PIT WITHOUT GAS PROXIMITY

**NOTE:** Refer to the NFPA54 (National Fuel Gas Code) for proper pipe sizing. See gas line sizing chart on page 7 as a reference.

1. Turn **OFF** gas supply system. **NOTE:** All gas connections (except for brass to brass) require the following. Clean pipe threads using either a wire brush or steel wool. Apply pipe sealant to the fittings before making any connection.

**BE CAREFUL!** Ensure all gas connections are snug, but do not over tighten!

2. Extend the gas supply system using minimum of 3/4" black iron pipe or an approved flexible gas line from existing house supply. This can be accomplished by teeing off or tapping into a gas line connection. Install necessary pipe for the distance required and then install a manual shut-off valve at the exterior house wall. If pipe is to pass through a foundation or house wall, make sure to re-seal the area around the pipe with weather sealant.

3. The primary gas shut-off (not supplied) will require a 3/8" male flared fitting to enable connection of the stainless steel flex gas line supplied with the fire pit (see Fig. 6 page 9).

### **IMPORTANT**

Installation of Natural or LP gas should be done by a qualified installer, service agency or gas supplier. This appliance must be isolated from the gas supply piping system by closing its manual shutoff valve during any pressure testing of the gas supply piping system at test pressures equal to or less than 1/2" psig (3.5kPa)

### VENTILATION FOR NON-COMBUSTIBLE ENCLOSURE

Fire pits are subjected to many outdoor elements such as rain, snow, wind, heat or cold. **A minimum of 18 square inches (two opposite sides) of cross ventilation is required to keep the components in good working order.** Use Fig. 4 as guide to assist to incorporate proper ventilation.

### HIGH ELEVATION INSTALLATION

This appliance is listed for elevations from 0- 4500 feet in Canada and the U.S. If elevation exceeds 4500 feet it may be necessary to decrease the input rating by changing the existing burner orifice to a smaller size. Input should be reduced 4% for each 1000 feet beyond the 4500 feet above sea level. Check with your local gas utility for assistance in determining the proper orifice in your location. In some cases the heating value may already be reduced and downsizing the orifice may not be necessary.

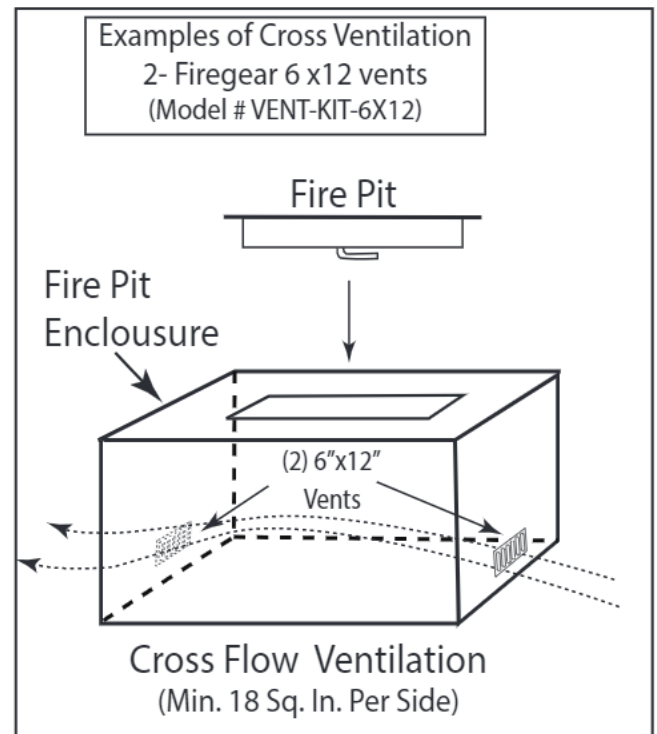

Fig. 4 Cross ventilation example



# GAS PIPE SIZING CHART

## NATURAL GAS : PIPE SIZING CHART

Length of Pipe in Feet	1/2"	3/4"	1"	1 - 1/4"	1 - 1/2"	2"	2 - 2 1/2"	3"	4"
10	108	230	387	793	1237	2259	3640	6434	-
20	75	160	280	569	877	1610	2613	5236	9521
30	61	129	224	471	719	1335	2165	4107	7859
40	52	110	196	401	635	1143	1867	3258	6795
50	46	98	177	364	560	1041	1680	2936	6142
60	42	89	159	336	513	957	1559	2684	5647
70	38	82	149	317	476	896	1447	2492	5250
80	36	76	140	239	443	840	1353	2315	4900
90	33	71	133	275	420	793	1288	2203	4667
100	32	68	126	266	411	775	1246	2128	4518
125	28	60	117	243	369	700	1143	1904	4065
150	25	54	105	215	327	625	1008	1689	3645
175	23	50	93	196	303	583	993	1554	3370
200	22	47	84	182	280	541	877	1437	3160
300	17	37	70	145	224	439	686	1139	2539

- Natural Gas (NG) flow is given in thousands of BTU/hr. = 1 cubic foot of NG gas - 1000 BTU
- Nominal pressure at the burner for Natural Gas is 3.5" of water column. (Typical machine supply 5"-7")
- Pipe length must include additional length for all fittings. Add approximately 5 feet of pipe per fitting.
- Natural Gas Example: A machine with a burner that requires 440,000 BTU would need a 1 -1/4" pipe for a 20" long run.

## LIQUID PROPANE : PIPE SIZING CHART

Length of Pipe in Feet	1/2"	3/4"	1"	1 - 1/4"	1 - 1/2"	2"	2 - 2 1/2"	3"	4"
10	275	567	1071	2205	3307	6221	10140	17990	35710
20	189	393	732	1496	2299	4331	7046	12510	25520
30	152	315	590	1212	1858	3465	5695	10110	20620
40	129	267	504	1039	1559	2992	4778	8481	17300
50	114	237	448	913	1417	2646	4343	7708	15730
60	103	217	409	834	1275	2394	3908	6936	14150
70	89	185	346	724	1086	2047	3329	5908	12050
80	78	162	307	630	976	1811	2991	5309	10830
90	69	146	275	567	866	1606	2654	4711	9613
100	63	132	252	511	787	1496	2412	4281	8736
125	54	112	209	439	665	1282	2083	3618	7382
150	48	100	185	390	590	1138	1808	3210	6549
175	43	90	168	353	534	1030	1637	2905	5927
200	40	83	155	325	491	947	1505	2671	5450
300	37	77	144	303	458	887	1404	2492	5084

- Liquid Propane (LP) Gas flow is given in thousands of BTU/hr. = 1 cubic foot of LP gas - 2500 BTU.
- This chart refers to low pressure LP, after regulation, Standard nominal pressure at the burner for Liquid Propane Gas is 11" of water column.
- Pipe length must include additional length for all fittings. Add approximately 5 feet of pipe per fitting.
- LP Example: A machine with a burner that requires 440,000 BTU would need a 1" pipe for a 20" long run.

NOTE: The sizing charts above list the specific pipe sizes required for the amount of BTU's for a new gas line installations. If you are using an existing gas line you must take into consideration the existing gas line capacities to ensure you will have proper pressure. **This chart is for reference only, we recommend you consult with a Licensed Plumber/Gas Fitter or NFPA54 (National Fuel Gas Code - current edition) for more details.**

Table 4 Gas pipe sizing.



## INSTALLATION OF FIRE PIT INTO AN APPROVED ENCLOSURE

### REQUIREMENTS

1. Only non-combustible materials should come in direct contact with any part of the fire pit. Underneath area should be non-combustible or a flat level combustible surface according to the clearances specified in this manual.
2. Refer to the NFPA54 (National Fuel Gas Code) for proper pipe sizing. Determine the size of the fire pit you are preparing to install (Refer to page 7).
3. Determine the size of the fire pit you are preparing to install (Refer to page 4).
4. You must provide a rectangular opening cutout to place the fire pit into the non-combustible enclosure. Refer to Table 1, dimension A.
5. Follow the local code requirements for the gas type being used. This fire pit should be installed in accordance with local codes and ordinances or in the absence of local codes, with the latest National Fuel Gas Code, ANSI Z223.1 NFPA54 or CSA B149.1, Natural and Propane Installation Code in Canada.
6. Fire pits create high temperatures, it is very important to have any combustibles at a safe distance.
7. **CAUTION: A minimum of 18 square inches of cross ventilation (per side) is required to keep the enclosure dry. See Fig 4 on page 6.**
8. These products are designed for outdoor use only. Not approved for any indoor use.
9. This fire pit is designed to have Firegear Outdoors lava rock or glass media completely covering the burner tube, so that the burner is not visible. Do not cover more than 1" above the top of burner. Use lava rock a minimum of 1" diameter as a base to fill the burner pan. DO NOT USE STONE OR RIVER ROCK.
10. Gas lines and fittings must be installed in to the non-combustible structure. All gas connections must be leak tested before installation of the fire pit. Soapy water leak detection is required before regular use of the fire pit.
11. Do not use media that will absorb moisture over time and will not release this moisture quickly. Moisture can boil in this material and can rapidly break apart and cause damage or personal injury. See Caution at bottom of page 3.
12. Never leave any combustible material on top of the fire pit. This could cause unsafe operation of this system and damage to the component that will not be covered under our warranty.
13. Ensure proper water drainage is also incorporated into the fire pit enclosure.

### INSTALLING CONTROL PANEL

Find a suitable location to mount the control panel. The control panel installs using the four ¼" mounting holes shown in Fig. 5. .

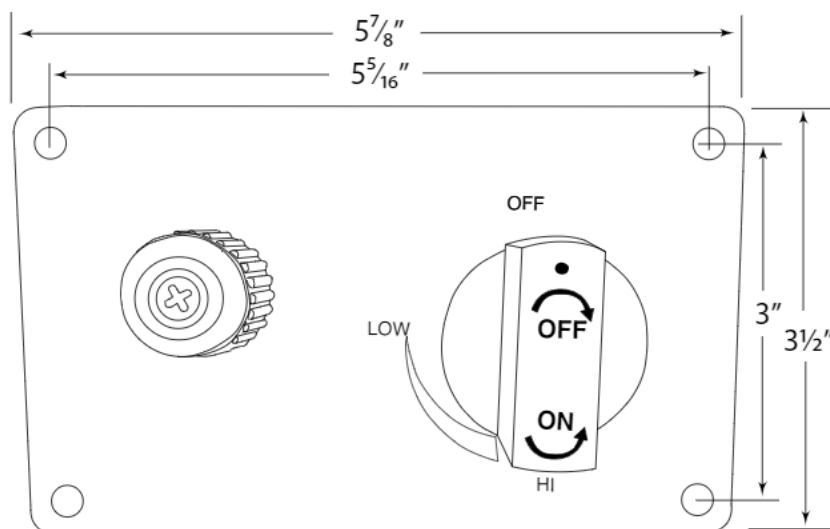
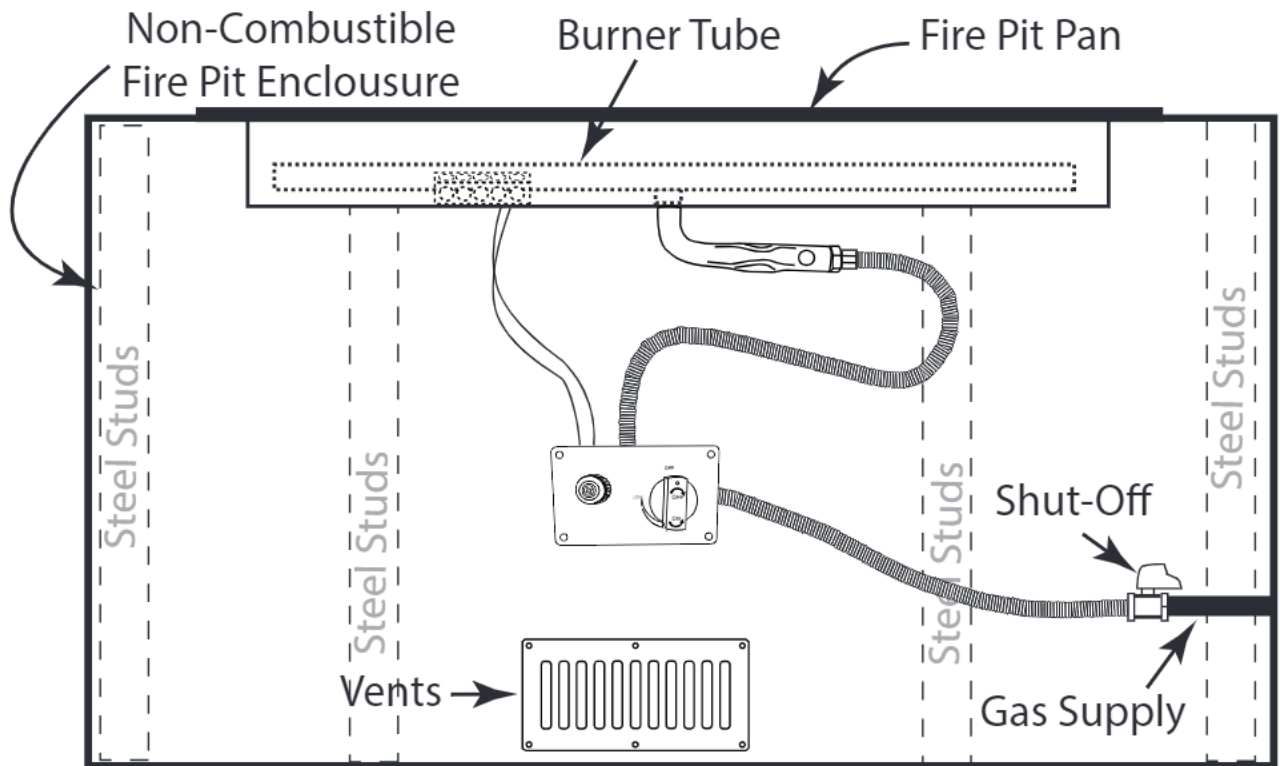

Fig. 5 Preparing TMSI control panel dimensions.





**NOTE:** Gas shut-off is not supplied.

**Fig. 6** Typical installation.

### INSTALLING BATTERY INTO PIEZO IGNITOR

1. Unscrew (counterclockwise) red ignitor knob/button and remove.
2. Insert AA battery (-) negative end into the ignitor battery compartment.
3. Install (clockwise) red ignitor knob/button.

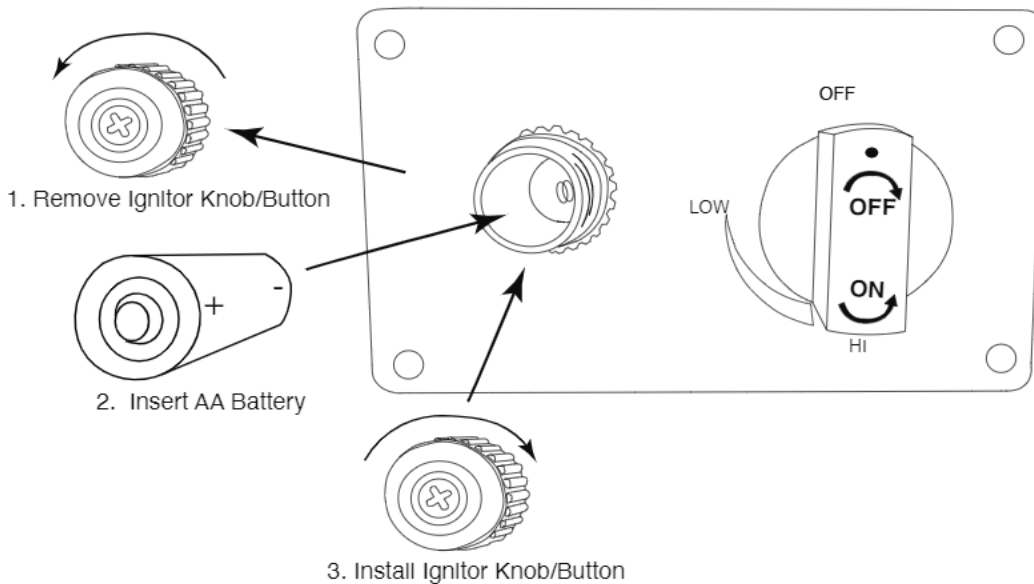

**Fig. 7** Piezo ignitor battery installation.

## OPERATION

**CAUTION:** Children and adults should be alerted to the hazards on high surface temperatures and should stay away to avoid burns or clothing ignition. Young children should be carefully supervised when they are in the area of the appliance.

**WARNING:** Do not use this appliance if any part has been under water. Immediately call a qualified service technician to inspect the appliance and to replace any part of control system and any gas control, which has been under water.

### SAFETY WARNINGS

1. Never leave the fire pit unattended during operation.
2. Clothing or other flammable materials should not be placed on or near the appliance.
3. Any guard or other protective device removed for servicing the appliance must be replaced prior to operating the appliance.
4. Installation and repair should be done by a qualified service person. The appliance should be inspected before use and at least annually by a qualified service person. More frequent cleaning may be required as necessary. It is imperative the control compartment, burners and circulating air passageways of the appliance be kept clean.
5. Inspect the fuel supply connection before each use of the appliance.
6. Temporary storage of this appliance indoors is permissible only if it has been disconnected from its fuel supply (Natural or L.P. gas line).

### WARNING

1. This appliance is hot when operated and can cause severe burns if contacted.
2. Do not burn any solid fuels in this appliance.

## LIGHTING INSTRUCTIONS

### READ ALL WARNING AND SAFETY INFORMATION ABOVE BEFORE ATTEMPTING TO LIGHT FIRE PIT

**CAUTION:** Ensure you have leak tested the fire pit before operating.

### TURNING ON FIRE PIT

1. Slightly push inward and turn control knob to HI position and release knob (See Fig. 8)
2. Press RED ignitor button inward (sparking in burner pan should occur) then press control knob inward at the same time and hold. Gas should ignite within 10-15 seconds.
3. After 45 seconds release the control knob. **Note:** If burner does not light or stay ON, wait 5 minutes and repeat.
4. Adjust flame to desired flame height with the control knob.

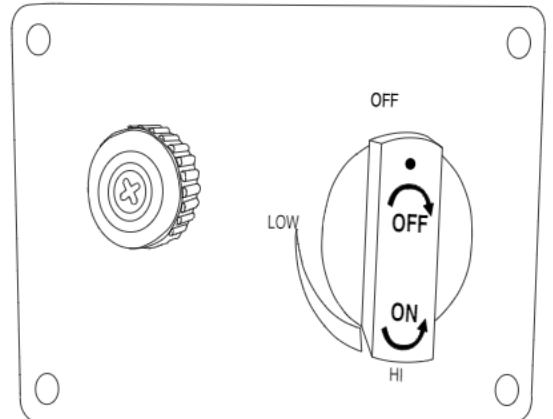
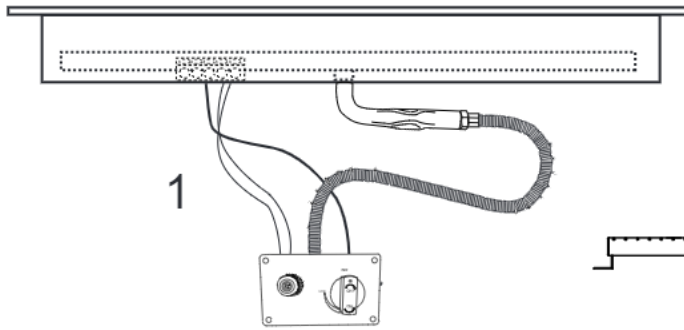

Fig. 8 Lighting fire pit with lighter

### TURNING OFF FIRE PIT

1. Push control knob inward and turn clockwise until fire pit shuts OFF. Wait 5 minutes to relight.
2. After fire pit cools down install cover/lid if applicable.

**TMSI REPLACEMENT PARTS**



1

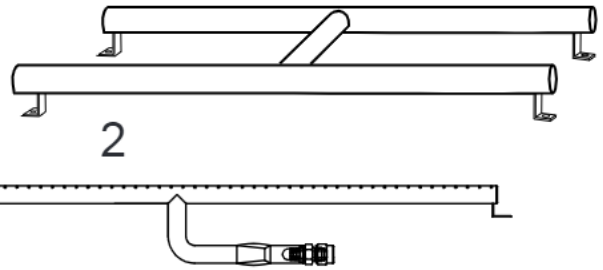

2

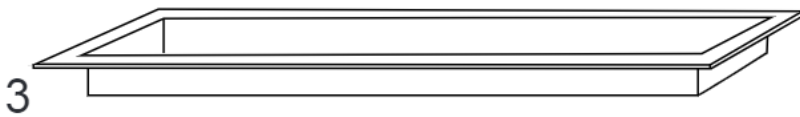

3

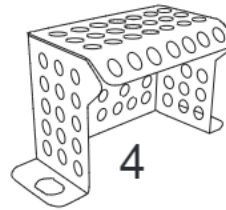

4



5

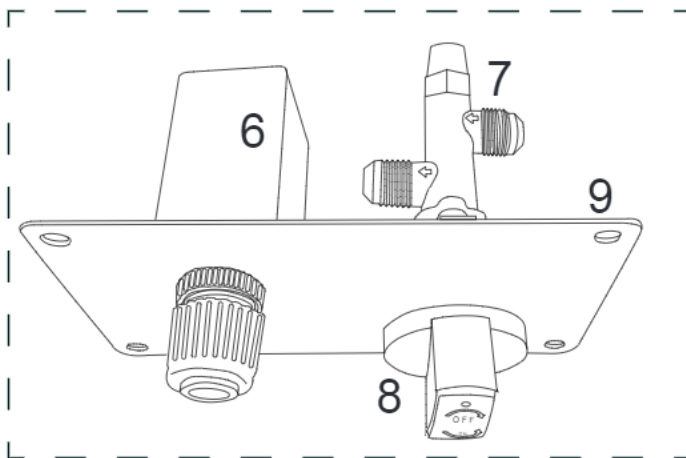

10

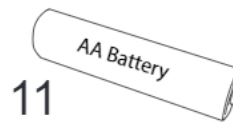

11

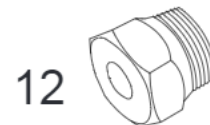

12

**Drawings not to scale.**

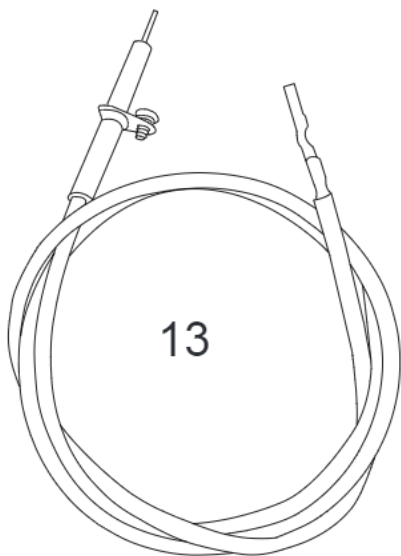

13

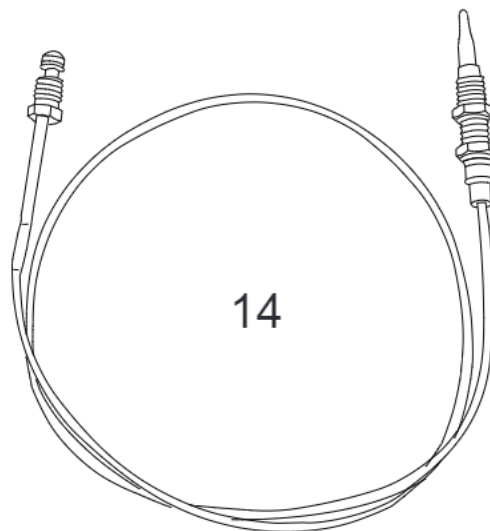

14

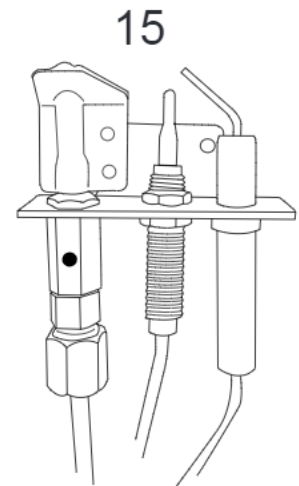

15

## TMSI REPLACEMENT PARTS

Item	Description	Qty.	Part Number
1	48" Complete H-burner assembly	1	LOF-48LHTMSI-N
1	48" Complete T-burner assembly	1	LOF-48LTTMSI-N
1	60" Complete T-burner assembly	1	LOF-60LTTMSI-N
2	48" H- Burner only	1	FG-H-48SS
2	48" T- Burner only	1	FG-T-48SS
2	60" T- Burner only	1	FG-T-60SS
3	48" H-Burner pan only (Refer to page 4 for specs)	1	PAN-SS4814L
3	48" T-Burner pan only (Refer to page 4 for specs)	1	PAN-SS4806L
3	60" T-Burner pan only (Refer to page 4 for specs)	1	PAN-SS6006L
4	Pilot Hood	1	FG-IGNITION-HOOD
5	Flex line (3/8" OD (1/4" ID) with 3/8" flare nuts) 22" long	1	T100-9898-22
6	Spark Ignitor Assembly (includes items #11 & 13)	1	FG-SPARK-IGN
7	Standing pilot gas valve	1	FG-GASVALVE-2
8	Gas control knob only	1	FG-CONTROL-KNOB
9	Control panel plate only	1	FG-CONTROL-FP
10	Control panel (includes items # 6, 7, 8, 9, 10, 11, 14)	1	FG-CONTROLPANEL2
11	AA battery	1	BATTAA
12a	Main burner orifice #3 (5.56mm) - NG	1	FG-OAS-NG03
12b	Main burner orifice #21 (4.20mm) - LP	11	FG-OAS-LP21
13	Ignitor (ignitor wire only)	1	FG-IGNITOR-WIRE
14	Thermocouple only	1	FG-THERMOCOUPLE
15	Natural gas pilot assembly	1	FG-IGNIT-ASSY-N
16	LP Conversion kit for (for all 48" & 60" models)	1	LOF-BOPO-LP21
17	Complete Pilot Assembly with Ignitor (not shown)	1	FG-IGNT-ASSY-PI

## MEDIA REQUIREMENTS

Firegear Outdoor glass media comes in 5 lb. bags, Lava Rock comes in 10 lb. bags or 50 lb. box and Lava Stones come in 50 lb. bag.

Model	Firegear Glass <i>Reflective (GRL) Beads (GB) Broken (GL)</i>	Firegear <i>Lava Rock</i>	Firegear <i>Lava Stones</i>
LOF-48LHTMSI-N	68 lbs.	44 lbs.	84 lbs.
LOF-48LTTMSI-N	27 lbs.	17 lbs.	34 lbs.
LOF-60LTTMSI-N	32 lbs.	22 lbs.	40 lbs.



## FIRE PIT MAINTENANCE

1. The fire pit should be inspected and cleaned before initial use at least annually by a qualified field service person.
2. Any component that is found faulty must be replaced with an approved component.
3. Any tampering or modifying with the fire pit is dangerous and voids all warranties.
4. During winter months in cold climates and various seasons operation of the fire pit may be affected by weather conditions. It is recommended to use a cover/lid overtop of your fire pit to protect it from humid/rainy weather conditions when not in use. Heavy rains/downpours could affect the fire pit operation if not covered; if this occurs ensure you allow the fire pit time to dry out before attempting to operate. **NOTE:** If a combustible type cover is used over the fire pit when not in use be sure to remove it before operation to prevent a severe safety hazard.
5. Over time stainless steel parts can discolor when heated, usually a golden or brown hue. This discoloration is normal and does not affect the performance of the appliance.

## TROUBLE SHOOTING

### Symptom

### Remedy

Fire pit won't light or stay lit

1. Bleed gas line.
2. Ensure all gas supply lines are turned ON.
3. Ensure there is not too much media overtop of burner; it can inhibit gas from flowing.
4. Check for soot/dirt on thermocouple, clean if necessary and re-light.
5. Check thermocouple voltage. Minimum voltage to operate system is 12-14mV.
5. Ensure thermocouple is correct height. Tip of thermocouple should be fully engulfed by flame and (approximately  $\frac{7}{8}$ " [22mm] to  $1\frac{1}{8}$ " [28mm] from base of bracket).
6. Check gas pressure.

Low flame

1. Ensure the base media is at least 1-inch in diameter and top media is no more than 1-inch over top of burner.
2. Ensure all shut-off valves and/or key valve is fully open.
3. Check gas pressure.

Water in my fire pit

1. Excess dust/sand material from media may be blocking the weep holes to relieve water. Remove all media and unplug weep holes. Clean or install new media free of dust and dirt.
2. Ensure fire pit enclosure has proper drainage for water and proper ventilation to dry out.

## OPTIONAL ACCESSORIES

The following accessories are available from your local Firegear dealer/distributor. Each accessory comes with a separate installation manual. Read each instruction thoroughly before installing.

Model	Description
LOF-BOPO-LP21	Propane conversion kit (main burner and pilot orifice)
VENT-6X12SS	(2) Stainless steel vents (Provides 18 sq. in. of ventilation per vent)
E-STOP2-5H	2 ½ -Hour mechanical gas timer valve with emergency shut-off
E-STOP1-0H	1 -Hour mechanical gas timer valve with emergency shut-off



## LOF-BOPO-LP21 (Natural to LP Gas Conversion)

This instruction will properly convert the fire pit from Natural gas to Propane (LP) gas. Follow the steps below to proceed. See replacement parts section for main burner LP orifice.

**Step 1:** Shut OFF gas supply.

**Step 2:** Remove media from fire pit.

**Step 3:** Carefully lift fire pit out of the enclosure.

**Step 4:** Remove the 3/8" flex connector from the main burner orifice. See Fig. 1 for reference.

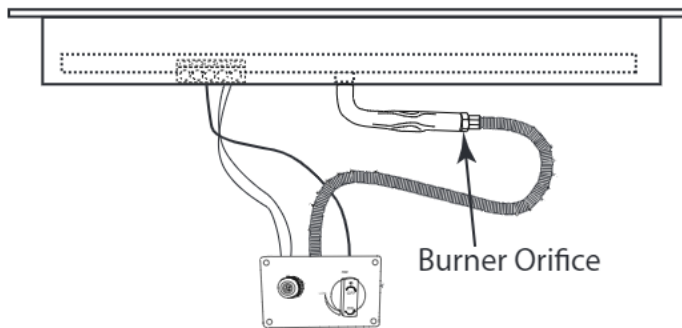

**Fig. 1** Shows main burner orifice location.

**Step 5:** Remove the flared fitting. Inside the end of the flared fitting is the main burner orifice. Remove the burner orifice and replace it with the new LP orifice for the correct model fire pit.

3/8" Flared Fitting

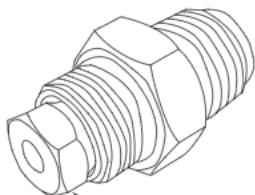

Main Burner Orifice  
(#LOF-BO-LP21)

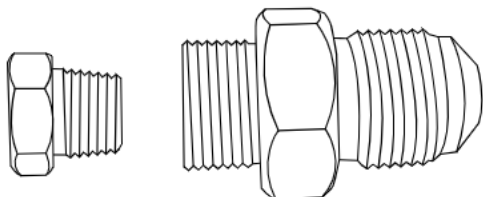

**Fig. 2** Shows main burner orifice.

**Note:** No Teflon tape or thread compound is required when threading brass to brass fittings.

**Step 6:** After the main burner orifice and brass fitting is removed then slide the air shutter sleeve off the burner tube and expose the hole for the LP gas.

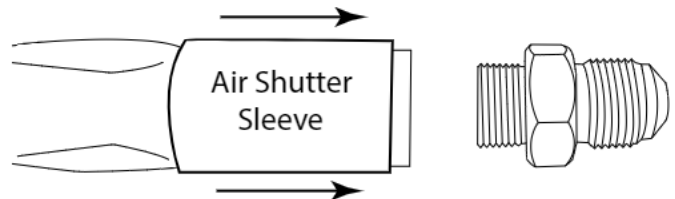

**Fig. 3.** Natural gas setting.

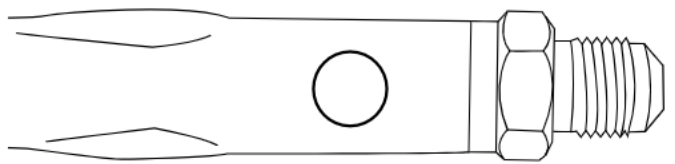
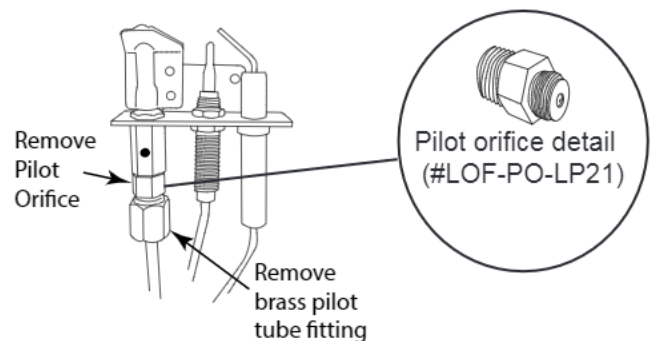

**Fig. 4** LP gas setting exposing hole in tube.

**Step 7:** Secure the main burner orifice and brass fitting back into the burner tube.

**Step 8:** Reattach the 3/8" flex connector to the flared fitting.

**Step 9:** First, remove the brass fitting from the pilot tube assembly. Then, unscrew the pilot orifice and replace it with new LP orifice. Finally, reattach the pilot tube fitting to the pilot assembly. See Fig. 5.



**Fig. 5** Pilot orifice location.

**Step 10:** Reinstall the fire pit into the enclosure, turn ON the gas supply and conduct a leak test before presuming normal use with the fire pit.

**Step 11:** Reinstall media.

**Step 12:** Installation is complete.



## LIMITED WARRANTY

Skytech Products Group (Firegear Outdoors) hereby warrants to the end user that products will be free from material and workmanship defects that prevent safe and correct operation of the product. The warranty commences from date of sale to the end user for the following period:

### CONSUMER/NON-COMMERCIAL APPLICATIONS:

Stainless Steel Components	5 Years
Gas Valve, Spark Igniter & Electronic Parts	2 Years
Log Sets	3 Years
Glass Windshields	5 Years
Glass Media	1 Year
Controls	5 Years
AnF Enclosures	5 Years
GFRC (Glass Fiber Reinforced Concrete)	1 Year

Lava Rock and Lava Stones are not covered by warranty

### COMMERCIAL APPLICATIONS:

Stainless Steel Components	1 Year
Gas Valve, Spark Igniter & Electronic Parts	1 Year
Log Sets	1 Year
Glass Windshields	1 Year
Glass Media	1 Year
Controls	1 Year
AnF Enclosures	1 Year
GFRC (Glass Fiber Reinforced Concrete)	1 Year

Lava Rock and Lava Stones are not covered by warranty

End User must provide a bill of sale, canceled check, or payment record from the end user to verify purchase date and to establish warranty period. This Limited Warranty shall be valid and limited to the original purchaser only.

**WARNING** Any modification to the product will void the warranty.

This Limited Warranty shall be limited to the repair and/or replacement of parts that have proven to be defective under normal use and service. Before returning any parts, contact our Technical Service Department for a Return Materials Authorization (RMA) number. All warranty claims must be made by the OEM / Distributor / Dealer account on behalf of the end user. You may contact Technical Service at (855) 498-8324.

All approved returned defects must be confirmed by our Technical Service Department. If the defect is confirmed and we approve the claim, we will replace such parts without charge. This warranty gives you specific legal rights, and you may also have other rights, which vary from state to state.

Travel, diagnostic cost, service labor to repair the defect and freight charges on warranty parts to and from the factory will be responsibility of the owner. We will not be responsible for labor charges and/or damage incurred in installation, repair, and replacement.

This Limited Warranty is voided if not assembled, installed and operated as intended. This Limited Warranty does not cover any defects due to accident, abuse, misuse, alteration, misapplication, vandalism, improper installation or improper maintenance or service, removal from the original location or re- installation into another location, or failure to perform normal and routine maintenance.

Damage due to severe weather conditions such as hail, hurricanes, earthquakes, tornadoes, discoloration due to over-heating, exposure to chemicals (including salt), either directly or in the atmosphere, or very high humidity, is not covered by this Limited Warranty.

There are no other express warranties except as set forth herein. For consumer applications, any applicable implied warranties of merchantability and fitness are limited in duration to the period of coverage of this Limited Warranty. Some states do not allow limitation on how long an implied warranty lasts, so this limitation may not apply to you.

For Commercial applications, the liability of Firegear Outdoors is limited to the express terms of this warranty. We expressly disclaim any and all implied warranties, including any warranties of fitness for a particular purpose or merchantability.

We are not liable for any special, indirect or consequential damages. Our maximum liability is limited to the purchase price of the purchased products. Some states do not allow the exclusion or limitation of incidental or consequential damages, so this limitation or exclusions may not apply to you.

We do not authorize any person or company to assume for it any other obligation or liability in connection with the sale, installation, use, removal, return, or replacement of its equipment; and no such representations are binding.

REV. 6/18





**FOR TECHNICAL SERVICE, CALL:**

**(855) 498-8324**

Firegear Outdoors  
9230 Conservation Way  
Fort Wayne, IN 46809  
Sales Support: (888)699-6167

**WEB SITE:** [www.firegearoutdoors.com](http://www.firegearoutdoors.com)





Having problems getting the fire pit to operate? Don't leave the job site!  
We want to help! Call 855.498.8324 for Technical Support  
between the hours of 8:00AM to 5:00PM EST.  
*Text photos to 260.255.5750 or e-mail photos to [support@skytechpg.com](mailto:support@skytechpg.com).*

**BEFORE YOU CALL WE WILL NEED THIS INFORMATION**

1. Model Number: \_\_\_\_\_
2. Serial Number: \_\_\_\_\_
3. How long is the gas line run? Nat Gas \_\_\_\_ LP Gas \_\_\_\_
4. What size is gas line? \_\_\_\_\_
5. Inlet Gas Pressure: \_\_\_\_\_ WC  
Manifold Gas Pressure: \_\_\_\_\_ WC
6. What type of media are you using? \_\_\_\_\_
7. Review the troubleshooting section in the installation manual.
8. What are the symptoms? Please be prepared to explain.
9. Be prepared to send photos to us when on the phone.
10. Found missing or damaged parts? Let us know ASAP or send photos.